



ASA DENTAL®

PROGETTAZIONE E PRODUZIONE STRUMENTI DENTALI
DESIGN AND MANUFACTURING OF DENTAL INSTRUMENTS

Conservativa

Restorative



*Dove nasce un sorriso...
Where smile rises...*



Set di Strumenti per Diga

Rubber Dam Instrument Kit

Contenuto/Contents:

- 2720-L Vassoio in acciaio inox
Stainless steel - instrument tray base
- 2720-U Coperchio in acciaio inox
Stainless steel - instrument tray lid
- 2730-3 Griglia portastrumenti in acciaio inox
Stainless steel - insert frame
- 3040-1 Telaio per diga in acciaio inox
Stainless steel - rubber dam frame
- 3031 Pinza per uncini Brewer
Brewer clamp forceps
- 3033 Pinza foradiga Ivory
Ivory punch forceps
- 2731-1 Vassoio porta-uncini in acciaio inox
Stainless steel - rubber dam clamp tray
- 3050-60 Uncino per premolari senza alette n. 60
No. 60 - wingless bicuspid clamp
- 3051-26 Uncino per molari senza alette n. 26
No. 26 - wingless molar clamp
- 3051-51 Uncino per molari senza alette n. 51
No. 51 - wingless molar clamp
- 3051-29 Uncino per premolari senza alette n. 29
No. 29 - wingless bicuspid clamp
- 3051-202 Uncino per molari con alette n. 202
No. 202 - wingless molar clamp
- 3051-205 Uncino per molari con alette n. 205
No. 205 - wingless molar clamp
- 3051-212 Uncino cervicale n. 212
No. 212 cervical clamp
- 3051-210 Uncino labiale con alette n. 210
No. 210 - winged labial clamp



S3000

Set di strumenti per diga realizzato secondo le indicazioni del Prof. GUIDO GORACCI, titolare della Cattedra di Odontoiatria Conservatrice presso l'Università degli Studi di Roma "LA SAPIENZA".

Rubber Dam Instrument Kit realised according to the instruction of Prof. GUIDO GORACCI, Senior Professor in the Department of Conservative Dentistry of Rome University, "LA SAPIENZA".

2730-3

Griglia porta strumenti per diga
Rubber dam instrument frame

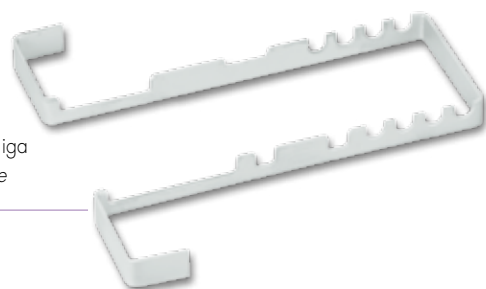

■ Vassoi porta-uncini

Rubber dam clamp trays



S2731-1

Vassoio porta-uncini in acciaio inox completo di 8 uncini.
Stainless steel rubber dam clamp tray with 8 different clamps.

Contenuto/ Contents: 3050-60, 3051-26, 3051-51, 3051-29, 3051-202, 3051-205, 3051-212, 3051-210, 2731-1

2731-1

Vassoio porta-uncini in acciaio inox (senza uncini).
Stainless steel rubber dam clamp tray (without clamps).



Dove nasce un sorriso...
Where smile rises...



Set di Strumenti per Diga

Rubber Dam Instrument Kit



S2731-12

Vassoio porta-uncini in acciaio inox completo di 12 uncini.
Stainless steel rubber dam clamp tray with 12 different clamps.

Contenuto/Contents: 3051-212, 3052-00, 3052-0, 3052-1, 3052-2A, 3052-3, 3052-7, 3052-8, 3052-8A, 3052-12A, 3052-13A, 3052-14, 2731-1

Numerazione dei denti

Tooth numbering

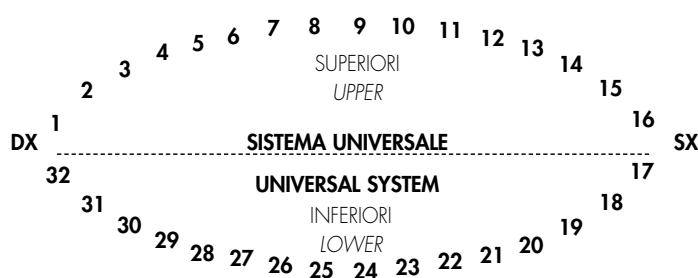

Classificazione

Classification



- W= Wingless** (uncini privi di alette)
- T= Tiger** (uncino con branche dentellate)
- N= Normal** (uncini con alette)

DENTI TEETH	FORME UTILIZZABILI PATTERN USED
Superiori/Upper: 1 - 2 - 3	4 - W4 - 8 - W8 - 8A - W8A 12A - 14 - 14T - W14 - 14A W14A - 26 - 51 - 205 - 202
4 - 5	0 - W0 - 1 - 1T - W1 - 2A 2AT W2A - 29
6 - 7 - 8 - 9 - 10 - 11	9 - 9T - 212 - 210
12 - 13	0 - W0 - 1 - 1T - W1 - 2A - 2AT W2A - 29
14 - 15 - 16	4 - W4 - 8 - W8 - 8A - W8A 13A - 14 - 14T - W14 - 14A W14A - 26 - 51
Inferiori/Lower: 17 - 18 - 19	3 - W3 - 7 - W7 - 8A - W8A 13A - 14 - 14T - W14 - 14A W14A
20 - 21	0 - W0 - 2A - 2AT - W2A - 2 2T - W2 - 29
22 - 23 - 24 - 25 26 - 27	00 - 9 - 9T - 212 - 210
28 - 29	0 - W0 - 2 - 2T - W2 - 2A - 2AT W2A - 29
30 - 31 - 32	3 - W3 - 7 - W7 - 12A - 14 14T W14 - 14A - W14A

*Dove nasce un sorriso...
Where smile rises...*



Uncini per Diga

Rubber Dam Clamps

Conservativa - Restorative

Anteriori Anterior



Con alette
Winged



**3052-9
Fig. 9**

Uncino labiale
Labial clamp

Con alette
Winged



**3052-9T
Fig. 9T**

Uncino labiale dentellato
Edged labial clamp



Con alette
Winged



**3051-212
Fig. 212**

Uncino cervicale
Cervical clamp



Con alette
Winged



**3051-210
Fig. 210**

Uncino labiale
Labial clamp

Premolari Premolars



Con alette
Winged



**3052-00
Fig. 00**

Con alette
Winged



**3052-0
Fig. 0**

Senza alette
Wingless



**3052-W0
Fig. W0**

Per denti di piccole dimensioni, allungati o stretti
For small teeth, elongated or with narrow collars



Con alette
Winged



**3052-1
Fig. 1**

Con alette
Winged



**3052-1T
Fig. 1T**

Senza alette
Wingless



**3052-W1
Fig. W1**

Per uso generale, con branche adattabili alle curvature delle linee gengivali
For general use with adjustable jaws according to gingival line shapes



Con alette
Winged



**3052-2A
Fig. 2A**

Dentellato, con alette
Edged, winged



**3052-2AT
Fig. 2AT**

Senza alette
Wingless



**3052-W2A
Fig. W2A**

Per premolari, con colletto lungo
For premolars, with elongated collar



Con alette
Winged



**3052-2
Fig. 2**

Dentellato, con alette
Edged, winged



**3052-2T
Fig. 2T**

Senza alette
Wingless



**3052-W2
Fig. W2**

Per premolari inferiori con colletto lungo
For lower premolars with elongated collar



Senza alette
Wingless



**3051-29
Fig. 29**



Senza alette
Wingless























**3050-60
Fig. 60**

Principalmente per premolari mandibolari
Primarily for lower premolars

Uncini per Diga

Rubber Dam Clamps

Molari
Molars

<p>Con alette Winged</p>  <p>3052-3 Fig. 3</p> <p>Per molari inferiori piccoli For small lower molars</p>		<p>Senza alette Wingless</p>  <p>3052-W3 Fig. W3</p>		<p>Con alette Winged</p>  <p>3052-4 Fig. 4</p> <p>Per molari piccoli con colletti tondeggianti For small molars with round collars</p>		<p>Senza alette Wingless</p>  <p>3052-W4 Fig. W4</p>			
<p>Con alette Winged</p>  <p>3052-7 Fig. 7</p> <p>Per molari inferiori di forma quadrata For square lower molars</p>		<p>Senza alette Wingless</p>  <p>3052-W7 Fig. W7</p>		<p>Con alette Winged</p>  <p>3052-8 Fig. 8</p> <p>Per molari superiori a forma tonda For round upper molars</p>		<p>Senza alette Wingless</p>  <p>3052-W8 Fig. W8</p>			
<p>Con alette Winged</p>  <p>3052-8A Fig. 8A</p> <p>Per radici di molari For molar roots</p>		<p>Senza alette Wingless</p>  <p>3052-W8A Fig. W8A</p>		<p>Dentellato, con alette Edged, winged</p>  <p>3052-12A Fig. 12A</p> <p>Per molari parzialmente rotti For partially broken molars</p>		 <p>3052-13A Fig. 13A</p>			
<p>Con alette Winged</p>  <p>3052-14 Fig. 14</p>		<p>Dentellato, con alette Edged, winged</p>  <p>3052-14T Fig. 14T</p>		<p>Senza alette Wingless</p>  <p>3052-W14 Fig. W14</p>		<p>Con alette Winged</p>  <p>3052-14A Fig. 14A</p>		<p>Senza alette Wingless</p>  <p>3052-W14A Fig. W14A</p>	
<p>Per molari tondi, parzialmente rotti, sottodimensionati o inclinati For round molars, partially broken, undersized or inclined</p>									
<p>Senza alette Wingless</p>  <p>3051-26 Fig. 26</p> <p>Per molari superiori For upper molars</p>		<p>Senza alette Wingless</p>  <p>3051-51 Fig. 51</p>		<p>Con alette Winged</p>  <p>3051-202 Fig. 202</p> <p>Per grandi molari superiori For big upper molars</p>		<p>Con alette Winged</p>  <p>3051-205 Fig. 205</p>			



Dove nasce un sorriso...
Where smile rises...

ASA DENTAL®

Strumenti per Diga

Rubber Dam Instruments



3032 Pinza foradiga Ainsworth
Ainsworth punch forceps



Diga inserita su molare superiore
Rubber dam placed on an upper molar

Pinze per forare la diga
Punch forceps



3032
Ainsworth
cm. 17



3033
Ivory
cm. 17

Spingibande
Band pusher



2410
Merston
cm. 14

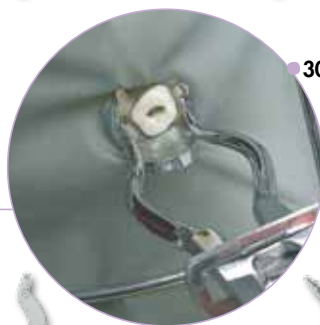

3031 Pinza per uncini Brewer
Brewer clamp forceps

Pinze per uncini
Clamp-forceps



3030
Ivory lightweight
cm. 17

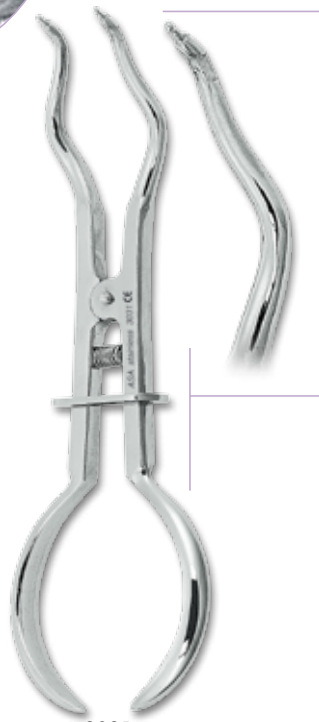

3031
Brewer
cm. 17,5

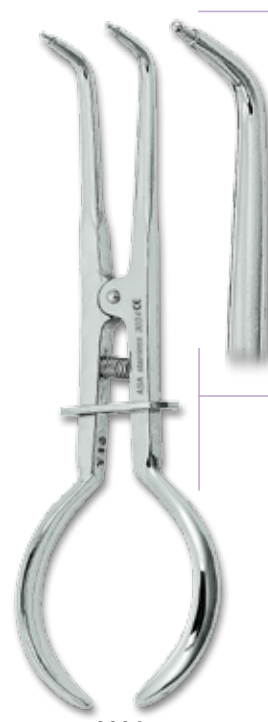

3034
Stoke
cm. 17,5

Dove nasce un sorriso...
Where smile rises...

ASA DENTAL®

Strumenti per Diga

Rubber Dam Instruments

Diga in lattice confezionata in sottovuoto. Confezione da 36 pezzi
15x15 cm. (6"x 6")

*Latex dam vacuum packed. 36 pcs./pkg 15x15 cm. Ready cut
(6"x 6")*



3045



3040-1

cm. 10x10

Telaio per diga - inox
Rubber dam frame - stainless steel



3045 Diga in lattice
Latex dam

Telaio in plastica per diga.
Non necessita la rimozione durante la radiografia.
Sterilizzabile.

*Rubber dam frame in plastic.
Doesn't need to be removed during x-rays.
Sterilizable.*

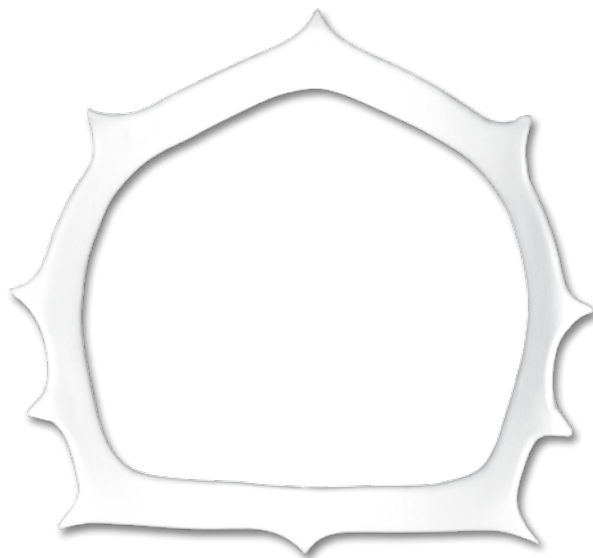

3041-1

Dove nasce un sorriso...
Where smile rises...



Spingi Amalgama

Amalgam Carriers

Conservativa - Restorative

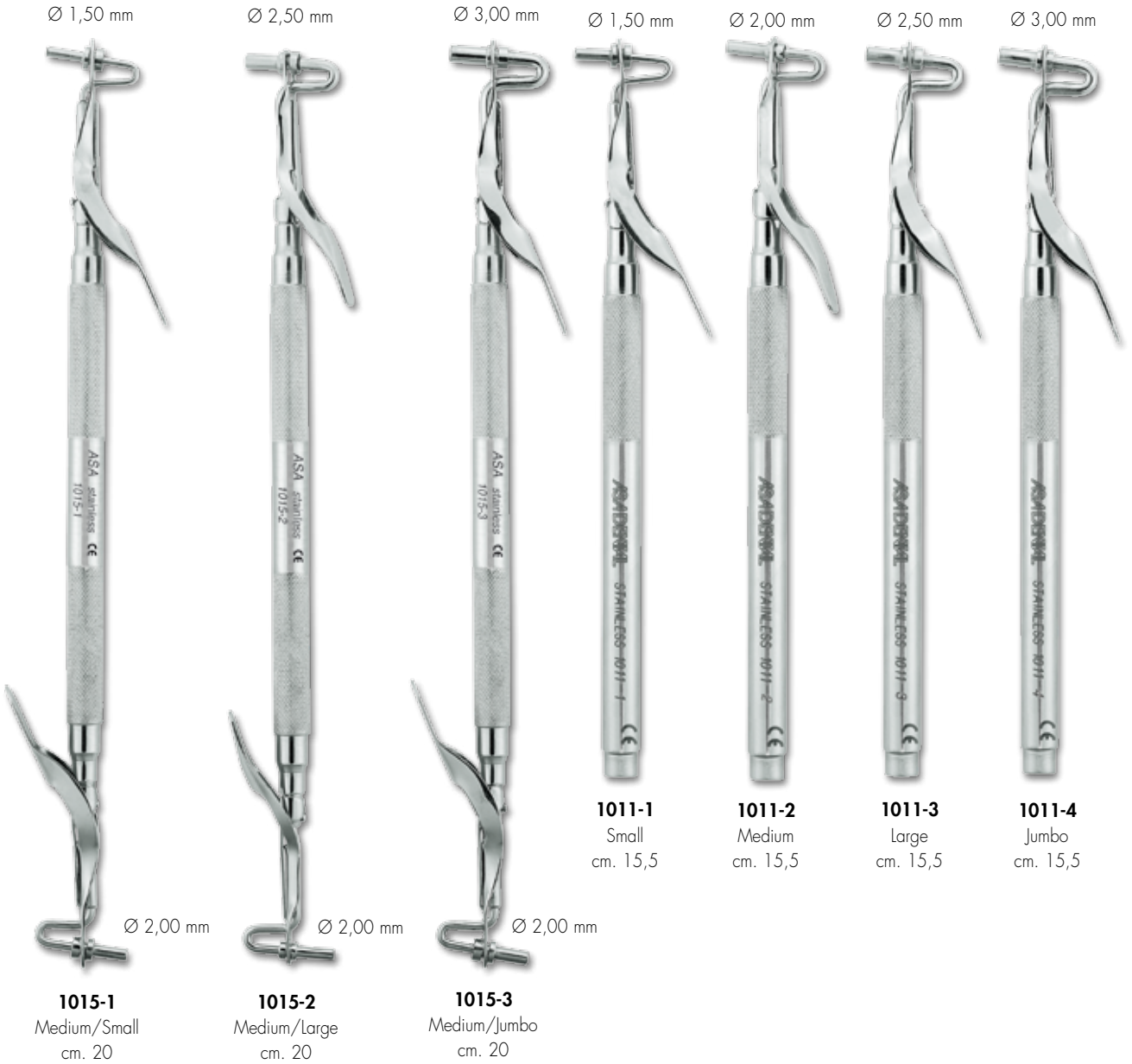

Mortai per amalgama
Amalgam wells



1030-1
Ø cm. 3,5
h. cm. 3,5



1030-2
Ø cm. 2
h. cm. 4



1030-3
Ø cm. 2
h. cm. 2,5

Dove nasce un sorriso...
Where smile rises...



Spingi Amalgama

Amalgam Carriers



Ø 2,00 mm

1020-2P

Punta in metallo per 1020-1-2-3
Metal tip for 1020-1-2-3

1020-1
Retto/Straight
Ø 2,00 mm
cm. 15

1020-2
45°
Ø 2,00 mm
cm. 15

1020-3
90°
Ø 2,00 mm
cm. 15

Spingi amalgama per retrogradi - retto
Amalgam carrier for retrograds - straight

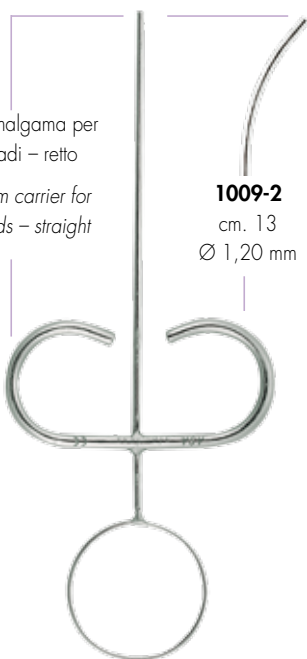

1009-1
cm. 13
Ø 1,20 mm

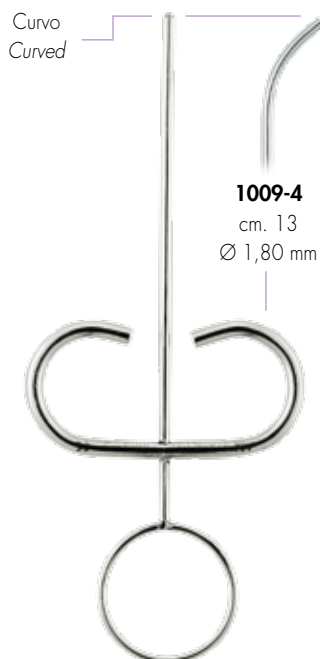

1009-3
cm. 13
Ø 1,80 mm

1009-2
cm. 13
Ø 1,20 mm

1009-4
cm. 13
Ø 1,80 mm

Curvo
Curved

Spingi amalgama in plastica autoclavabili
Autoclavable plastic amalgam carriers

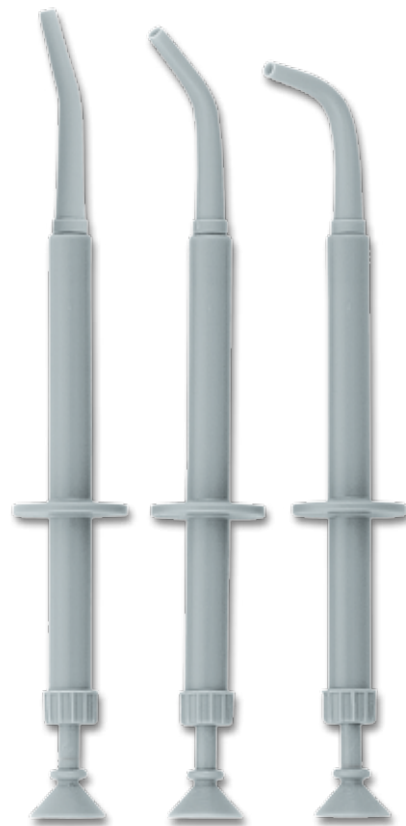

1021-1
Retto/Straight
Ø 2,00 mm
cm. 15,5

1021-2
45°
Ø 2,00 mm
cm. 15,5

1021-3
90°
Ø 2,00 mm
cm. 15,5

1021-1P

Punta di ricambio retta (conf. 10 pezzi)
Spare tip straight (bag of 10)



1021-2P

Punta di ricambio 45° (conf. 10 pezzi)
Spare tip 45° angled (bag of 10)



1021-3P

Punta di ricambio 90° (conf. 10 pezzi)
Spare tip 90° angled (bag of 10)



Dove nasce un sorriso...
Where smile rises...



Spatole per Cemento

Cement Spatulas

S0903-1

Serie da 5 pezzi Fig. 1
Set of 5 Fig. 1

S0903-2

Serie da 5 pezzi Fig. 2
Set of 5 Fig. 2

S0903-3

Serie da 5 pezzi Fig. 3
Set of 5 Fig. 3

S0903-4

Serie da 5 pezzi Fig. 4
Set of 5 Fig. 4



Piastria in vetro per miscelazione
Glass plate

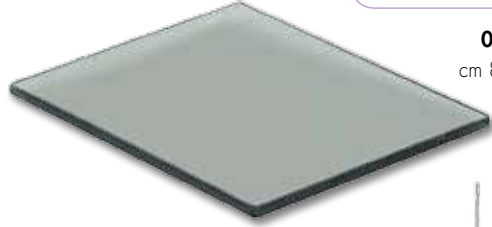

0999-1
cm 8x12x0,5



0900-1
Fig. 1

0900-2
Fig. 2

0903-00
Fig. 00

0903-0
Fig. 0

0903-1
Fig. 1

0903-2
Fig. 2

0903-3
Fig. 3

0903-4
Fig. 4

Dove nasce un sorriso...
Where smile rises...



Spatole Heidemann

Heidemann Separating Spatulas



S1102-1

Serie da 5 pezzi Fig. 1
Set of 5 Fig. 1



S1102-2

Serie da 5 pezzi Fig. 2
Set of 5 Fig. 2



S1102-3

Serie da 5 pezzi Fig. 3
Set of 5 Fig. 3

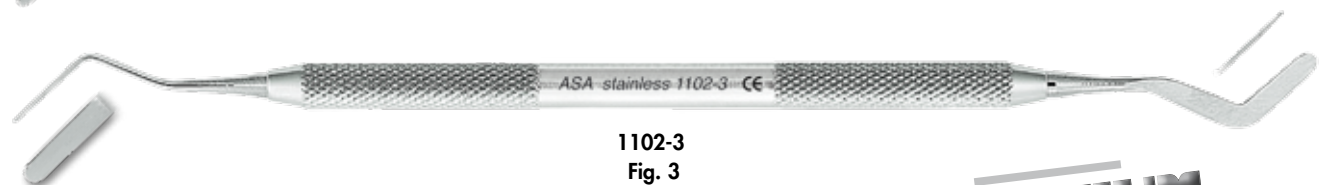
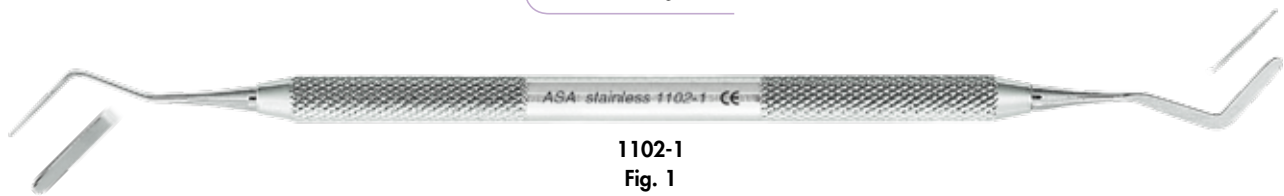

Spatule Heidemann con punte rivestite al nitruro di titanio
Heidemann separating spatulas with titanium nitride lining

**TITANIUM
GOLD FINISH**

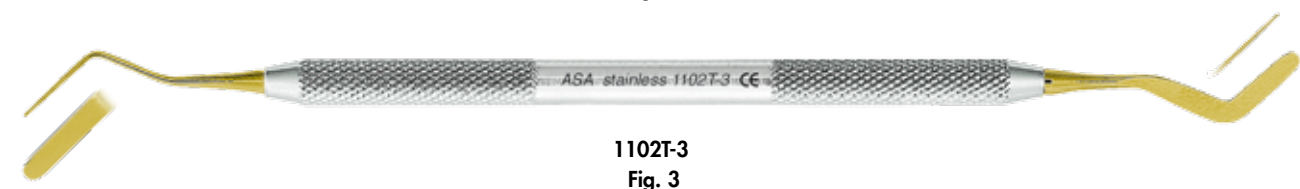

Dove nasce un sorriso...
Where smile rises...



Spatole Heidemann

Heidemann Separating Spatulas

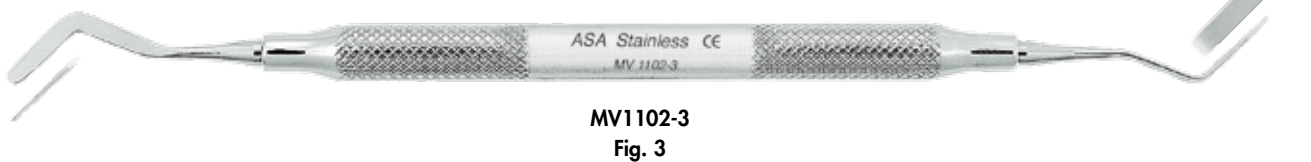
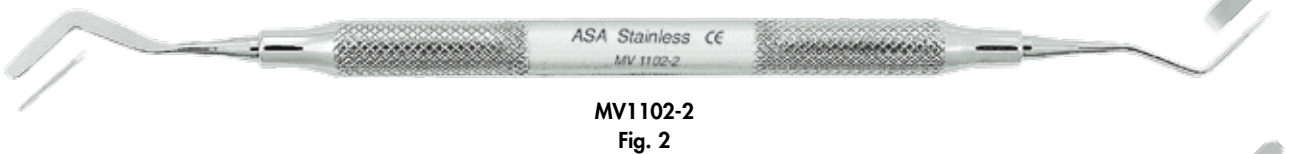
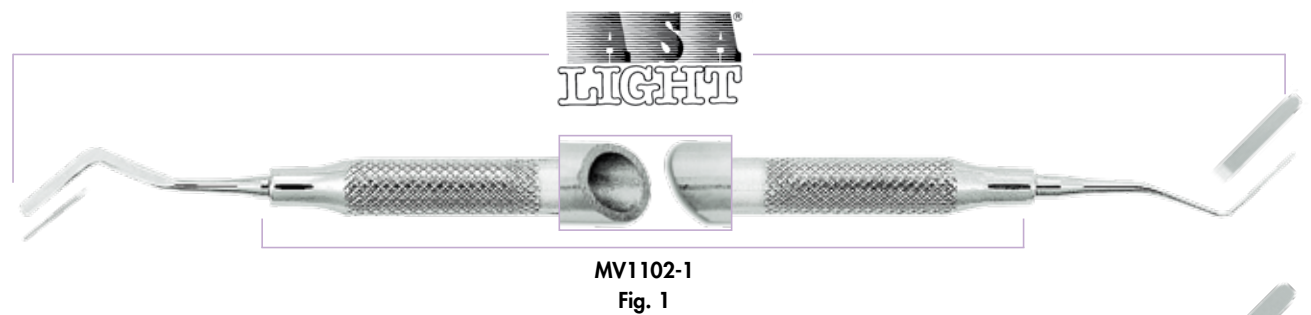
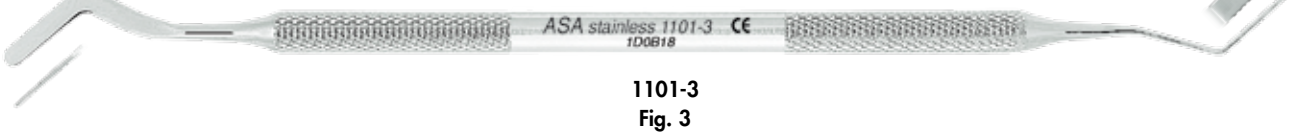
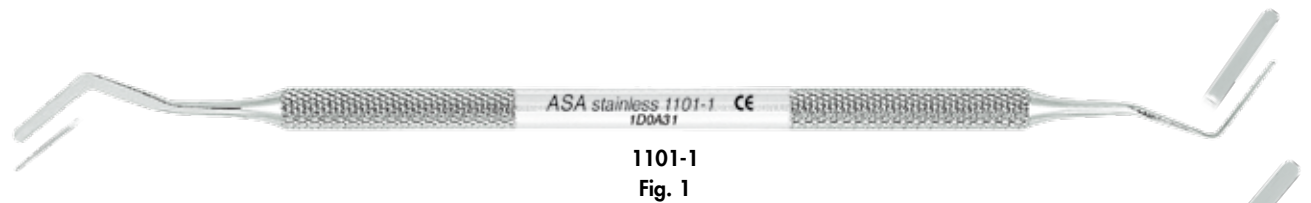
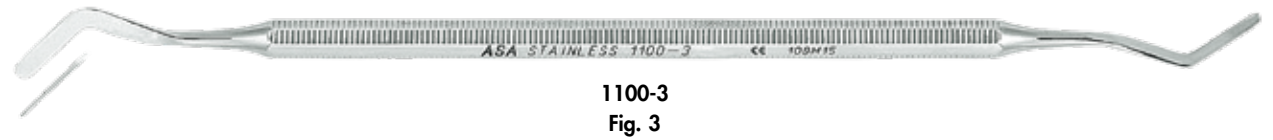
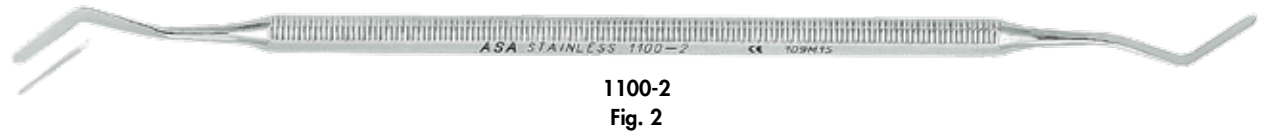
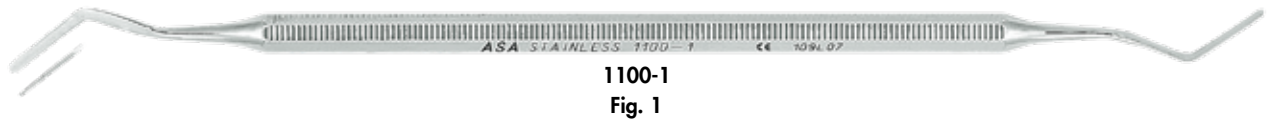

Dove nasce un sorriso...
Where smile rises...



Otturatori

Filling Instruments

S1200T

Serie da 5 strumenti "Titanium"
Set of 5 "Titanium" instruments

Contenuto/Contents: 1200T-1, 1202T-2,
1204T-1, 1102T-1, 1102T-2



**TITANIUM
GOLD FINISH**

■ Otturatori con punte rivestite al nitruro di titanio

Filling instruments with titanium nitride lining

Strumenti per amalgama
Amalgam instruments

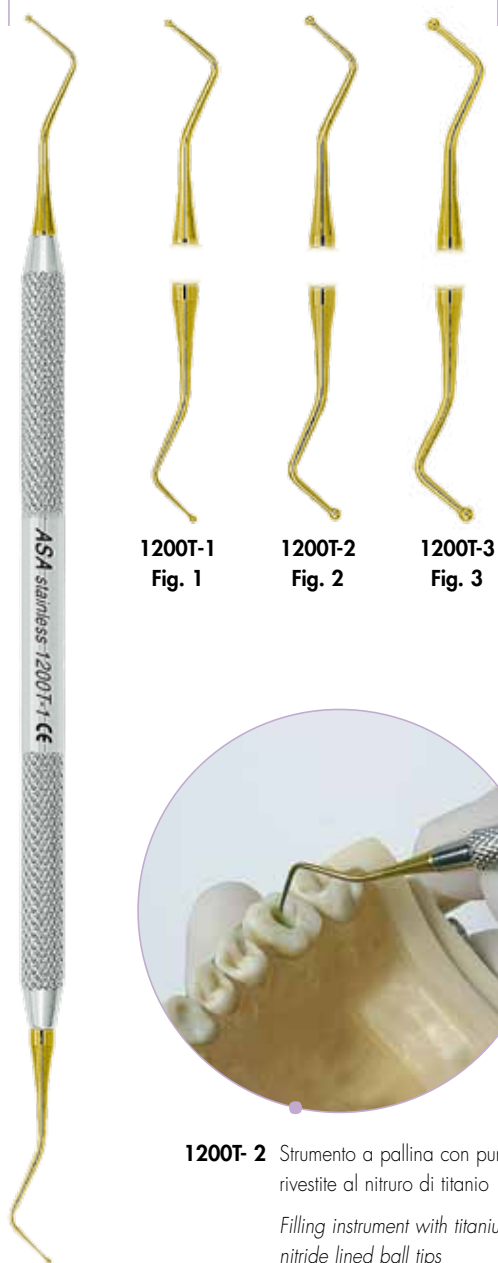

1200T-1
Fig. 1

1200T-2
Fig. 2

1200T-3
Fig. 3



1200T-2 Strumento a pallina con punte rivestite al nitruro di titanio
Filling instrument with titanium nitride lined ball tips

Zigrinati
Serrated

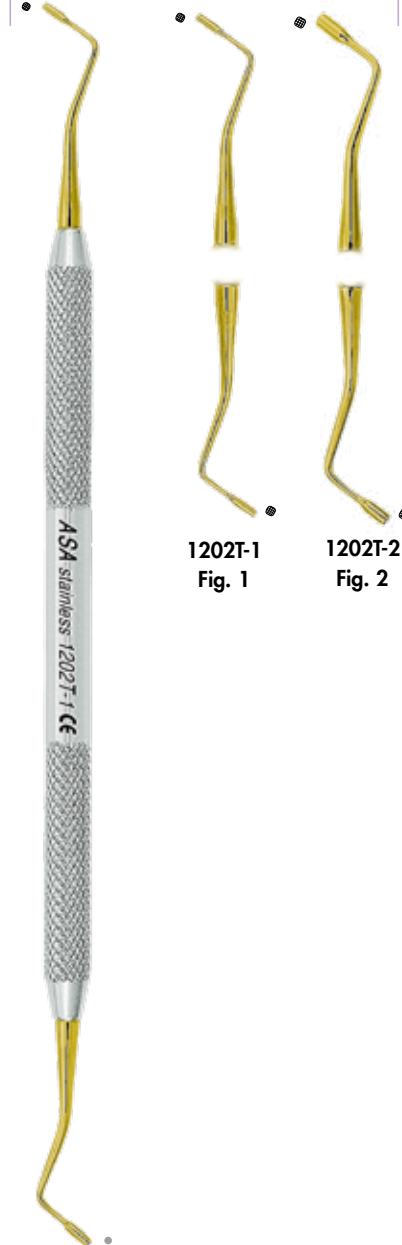

1202T-1
Fig. 1

1202T-2
Fig. 2



1204T-1
Fig. 1
Westcott

Dove nasce un sorriso...
Where smile rises...



Otturatori

Filling Instruments

S1200-1

Serie da 5 pezzi Fig. 1
Set of 5 Fig. 1

S1200-2

Serie da 5 pezzi Fig. 2
Set of 5 Fig. 2

S1200-3

Serie da 5 pezzi Fig. 3
Set of 5 Fig. 3

S1200-4

Serie da 5 pezzi Fig. 4
Set of 5 Fig. 4

S1200-5

Serie da 5 pezzi Fig. 5
Set of 5 Fig. 5



Conservativa - Restorative

Strumenti per amalgama
Amalgam instruments



1200-1
Fig. 1

1200-2
Fig. 2

1200-3
Fig. 3

1200-4
Fig. 4

1200-5
Fig. 5



1200-2 Otturatore a palla
Ball filling instrument

Zigrinati
Serrated

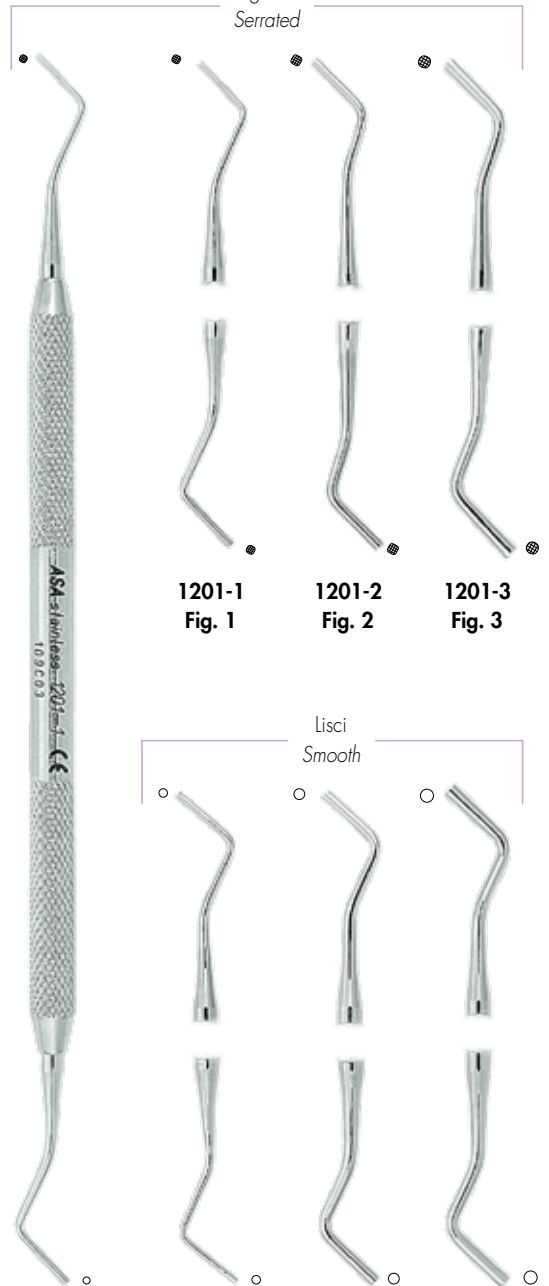

1201-1
Fig. 1

1201-2
Fig. 2

1201-3
Fig. 3

Lisci
Smooth



1201-1L
Fig. 1L

1201-2L
Fig. 2L

1201-3L
Fig. 3L

Otturatori

Filling Instruments



Strumenti per amalgama
Amalgam instruments

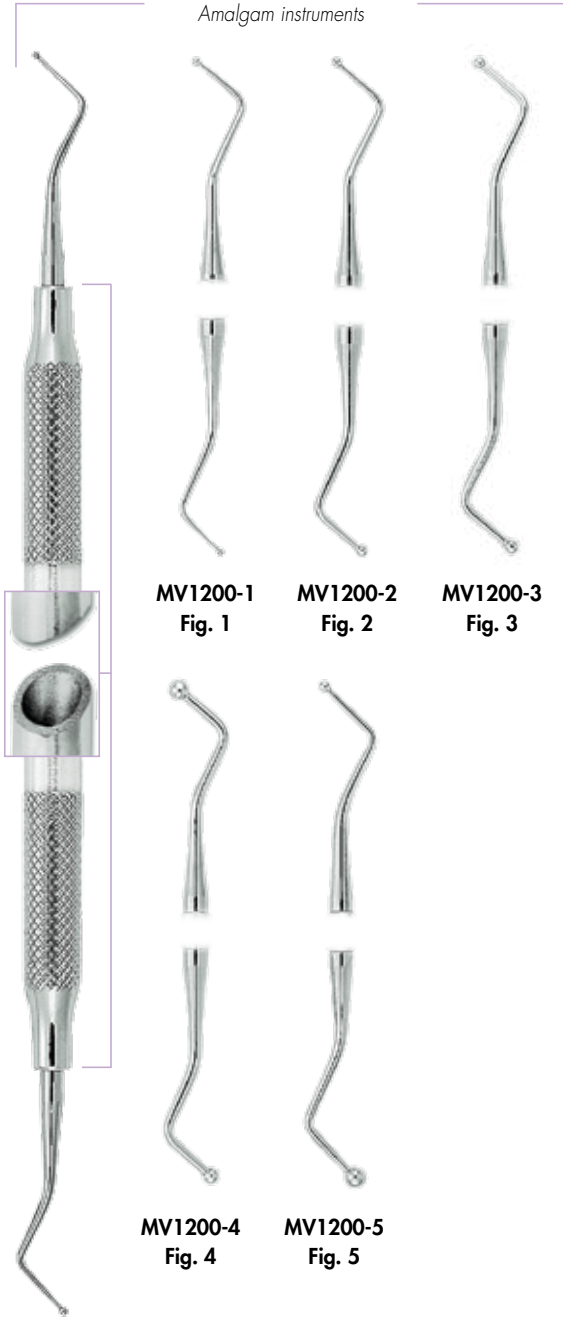

Zigrinati
Serrated

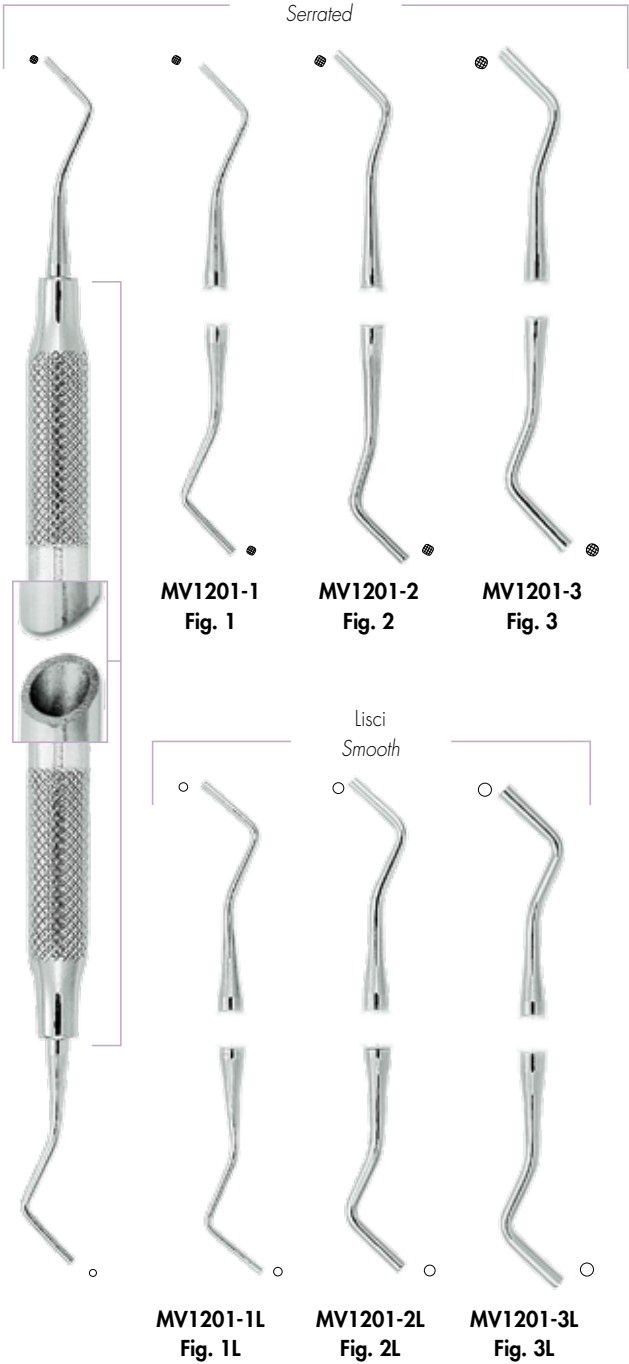

Dove nasce un sorriso...
Where smile rises...



Otturatori

Filling Instruments

Strumenti per amalgama
Amalgam instruments



1202-2 Otturatore universale cilindrico con punta zigrinata
Universal cylindric filling instrument with serrated tips

Zigrinati
Serrated

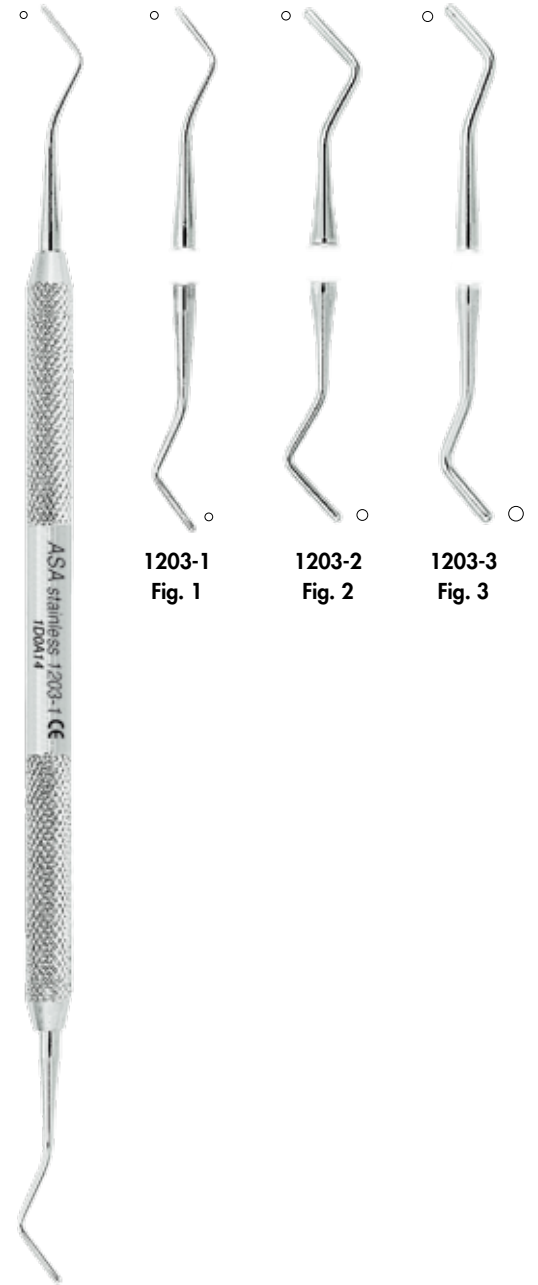
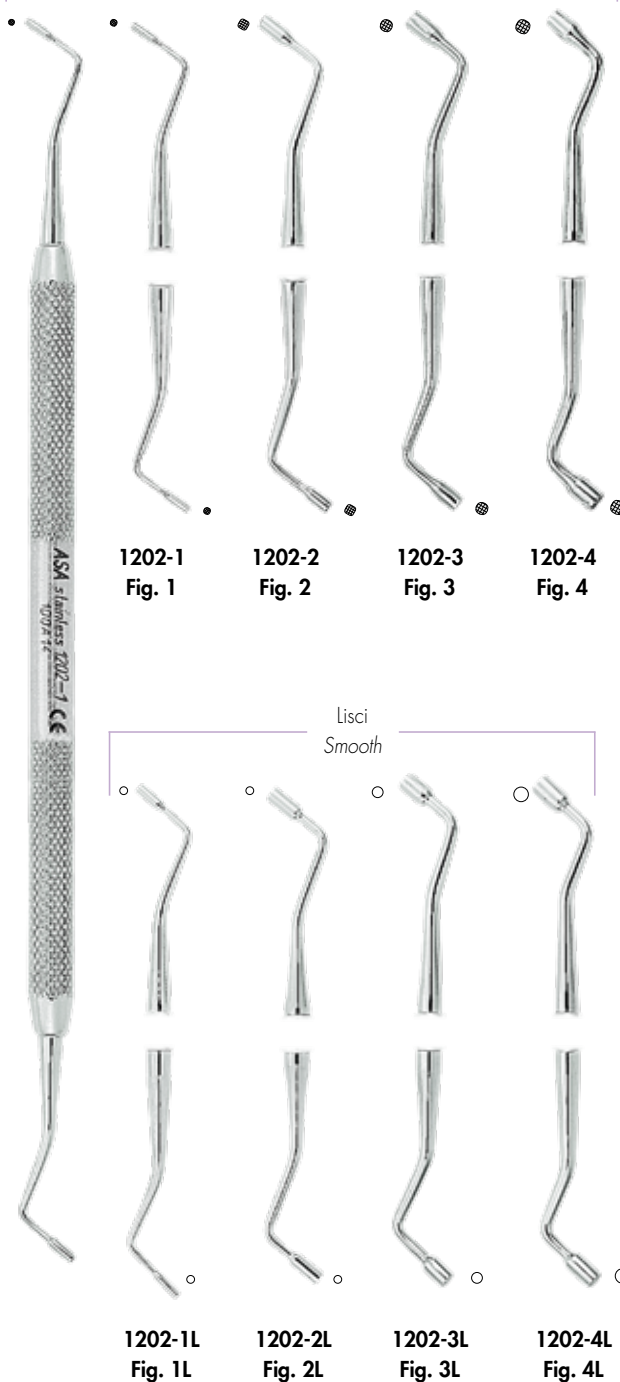

Lisci
Smooth

Dove nasce un sorriso...
Where smile rises...



Otturatori

Filling Instruments

Strumenti per amalgama
Amalgam instruments



Zigrinati
Serrated

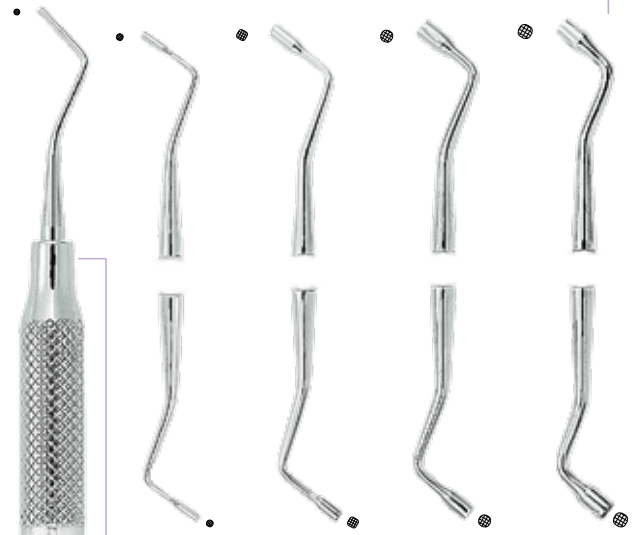

MV1202-1
Fig. 1

MV1202-2
Fig. 2

MV1202-3
Fig. 3

MV1202-4
Fig. 4



MV1203-1
Fig. 1

MV1203-2
Fig. 2

MV1203-3
Fig. 3

Lisci
Smooth

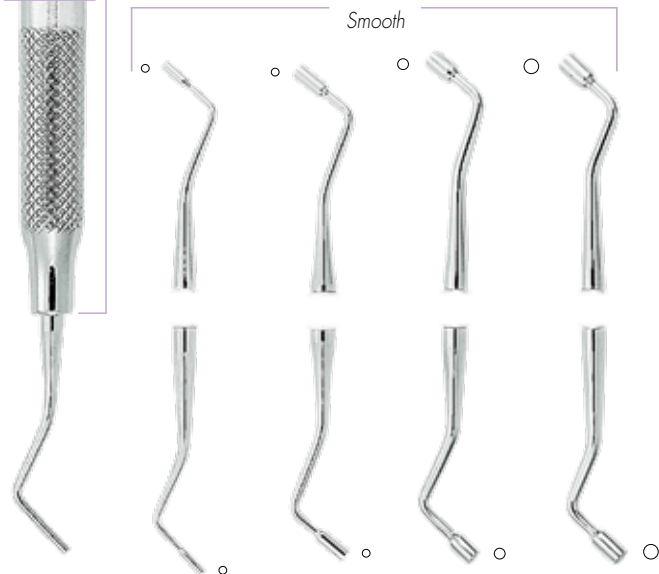

MV1202-1L
Fig. 1L

MV1202-2L
Fig. 2L

MV1202-3L
Fig. 3L

MV1202-4L
Fig. 4L

Dove nasce un sorriso...
Where smile rises...



Otturatori

Filling Instruments

Strumenti per amalgama

Amalgam instruments

Conservativa - Restorative



1205-1
Fig. 1
Ward



1205-2
Fig. 2
Ward



1211-0T
Fig. 0T
Tanner



1211-1T
Fig. 1T
Tanner



1211-2T
Fig. 2T
Tanner



1211-3T
Fig. 3T
Tanner



Zigrinato
Serrated

1212-01
Fig. 01
Marquette



1213-H1
Fig. H1
Hollenback



1213-H2
Fig. H2
Hollenback



1213-H3
Fig. H3
Hollenback



1213-H4
Fig. H4
Hollenback

Dove nasce un sorriso...
Where smile rises...



Otturatori

Filling Instruments

Strumenti per amalgama
Amalgam instruments



MV1205-1
Fig. 1
Ward



MV1205-2
Fig. 2
Ward



MV1211-0T
Fig. 0T
Tanner



MV1211-1T
Fig. 1T
Tanner



MV1211-2T
Fig. 2T
Tanner



MV1211-3T
Fig. 3T
Tanner



MV1212-01
Fig. 01
Marquette



MV1213-H1
Fig. H1
Hollenback



MV1213-H2
Fig. H2
Hollenback



MV1213-H3
Fig. H3
Hollenback



MV1213-H4
Fig. H4
Hollenback

Dove nasce un sorriso...
Where smile rises...

ASA DENTAL®

Otturatori

Filling Instruments

Strumenti per amalgama Markley Markley amalgam instruments

S1400
Serie da 6 pezzi
Set of 6



1400-1
Fig. 1
Markley



1400-2
Fig. 2
Markley



1400-3
Fig. 3
Markley



1400-4
Fig. 4
Markley



1400-5
Fig. 5
Markley



1400-6
Fig. 6
Markley

Dove nasce un sorriso...
Where smile rises...



Otturatori

Filling Instruments

Strumenti per amalgama Markley
Markley amalgam instruments



SMV1400
Serie da 6 pezzi
Set of 6

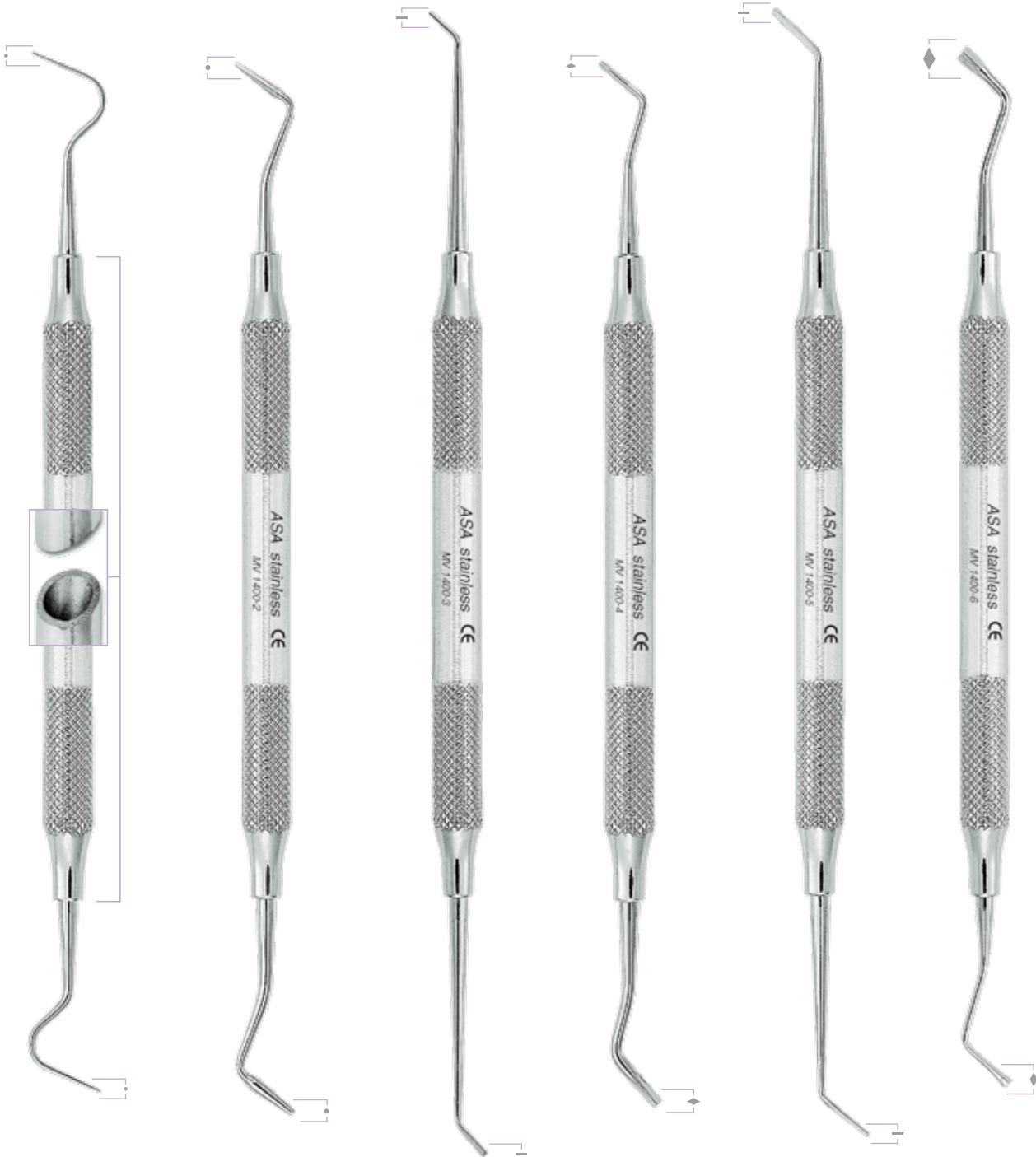

MV1400-1
Fig. 1
Markley

MV1400-2
Fig. 2
Markley

MV1400-3
Fig. 3
Markley

MV1400-4
Fig. 4
Markley

MV1400-5
Fig. 5
Markley

MV1400-6
Fig. 6
Markley

Dove nasce un sorriso...
Where smile rises...

ASA DENTAL®

Otturatori

Filling Instruments

■ Strumenti per amalgama Foc
Foc amalgam instruments

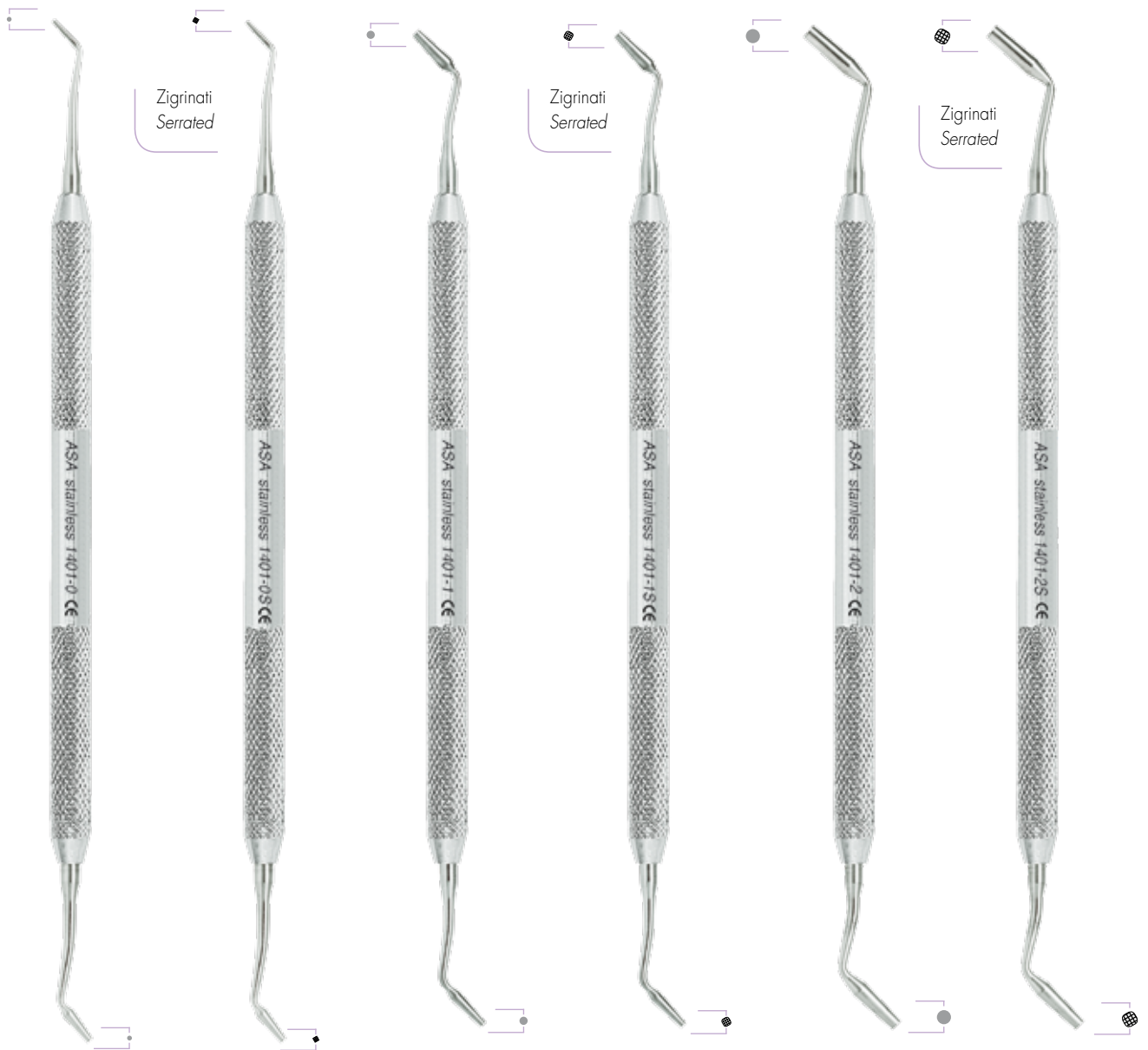

1401-0
Fig. 0
Foc

1401-0S
Fig. 0S
Foc

1401-1
Fig. 1
Foc

1401-1S
Fig. 1S
Foc

1401-2
Fig. 2
Foc

1401-2S
Fig. 2S
Foc

Dove nasce un sorriso...
Where smile rises...

ASA DENTAL®

Otturatori

Filling Instruments

Strumenti per amalgama Foc
Foc amalgam instruments



Zigrinati
Serrated



Zigrinati
Serrated



Zigrinati
Serrated



ML1401-0
Fig. 0
Foc

ML1401-0S
Fig. 0S
Foc

ML1401-1
Fig. 1
Foc

ML1401-1S
Fig. 1S
Foc

ML1401-2
Fig. 2
Foc

ML1401-2S
Fig. 2S
Foc

Dove nasce un sorriso...
Where smile rises...



Otturatori

Filling Instruments

■ **Brunitori**
Burnishers



● **1214-3** Brunitore Ladmore
Ladmore burnisher



1204-1
Fig. 1
Westcott



1204-2
Fig. 2
Westcott



1214-2
Fig. 2
Ladmore



1214-3
Fig. 3
Ladmore



1215-18
Fig. 18
Ball



1215-27S
Fig. 26-27S
Ball



1215-29
Fig. 27-29
Ball



1214-A
Fig. A



1215-W3
Fig. W3



1220-B2
Fig. NYU/B2



1221-31
Fig. 2/31

Dove nasce un sorriso...
Where smile rises...



Otturatori

Filling Instruments

■ **Brunitori**
Burnishers



MV1204-1
Fig. 1
Westcott



MV1204-2
Fig. 2
Westcott



MV1214-2
Fig. 2
Ladmore



MV1214-3
Fig. 3
Ladmore



MV1215-18
Fig. 18
Ball



MV1215-27S
Fig. 26-27S
Ball



MV1215-29
Fig. 27-29
Ball



MV1220-B2
Fig. NYU/B2



MV1221-31
Fig. 2/31

Dove nasce un sorriso...
Where smile rises...



Strumenti per Otturazioni Plastiche

Plastic Filling Instruments

■ **Strumenti per composito Felt**
Felt composite instruments

S1220

Serie da 6 pezzi
Set of 6



Alluminio
Aluminium



1220-1
Fig. 1
Felt

1220-2
Fig. 2
Felt

1220-3
Fig. 3
Felt

1220-4
Fig. 4
Felt

1220-5
Fig. 5
Felt

1220-6
Fig. 6
Felt

Dove nasce un sorriso...
Where smile rises...



Strumenti per Otturazioni Plastiche

Plastic Filling Instruments

**TITANIUM
GOLD FINISH**

- Strumenti per otturazioni plastiche con punte rivestite al nitruro di titanio
Plastic filling instruments with titanium nitride lined tips



1208T-1
Fig. 1

1208T-2
Fig. 2

1208T-3
Fig. 3

1209T-2
Fig. 2

1210T-2
Fig. 2

Pozzetti in plastica per miscelazione, 12 cavità, misura mm. 70x54x6 confezione da 1000 pezzi

Disposable mixing trays with 12 wells, dimensions mm. 70x54x6 - package of 1000



AL2735

AL2736

Spatoline in plastica in confezioni da 100 pezzi
Plastic mixing spatulas - package of 100

Dove nasce un sorriso...
Where smile rises...



Strumenti per Otturazioni Plastiche

Plastic Filling Instruments



1210-2 Spatola per otturazioni plastiche
Plastic filling instrument

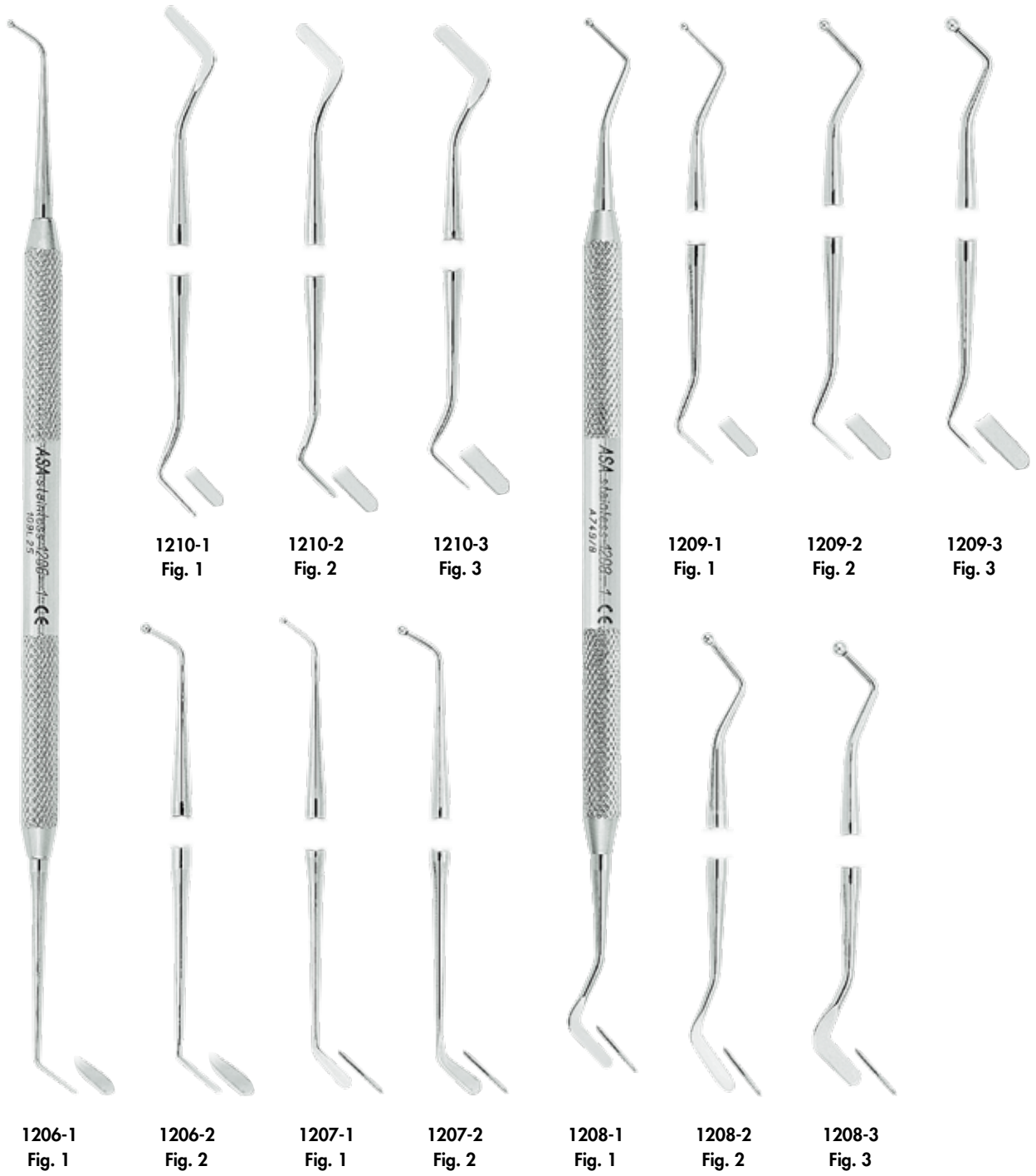

Conservativa - Restorative

Dove nasce un sorriso...
Where smile rises...



Strumenti per Otturazioni Plastiche

Plastic Filling Instruments



Conservativa - Restorative

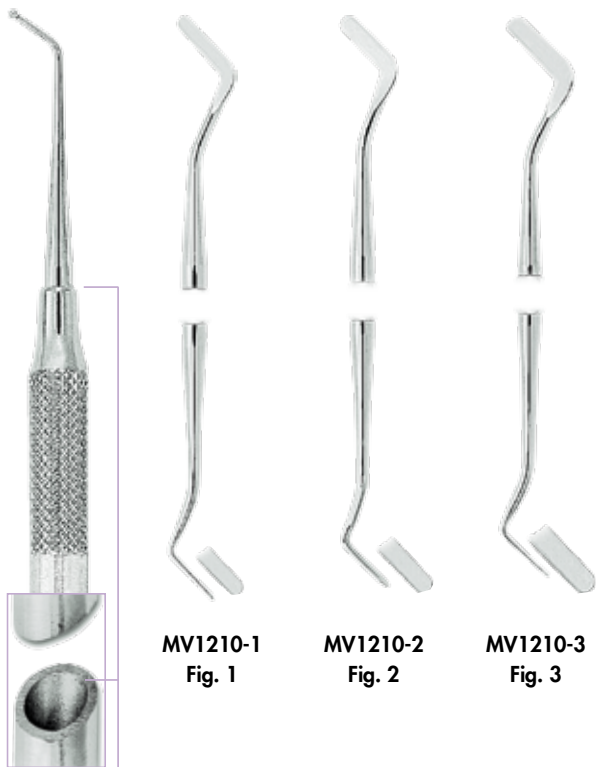

MV1210-1
Fig. 1

MV1210-2
Fig. 2

MV1210-3
Fig. 3

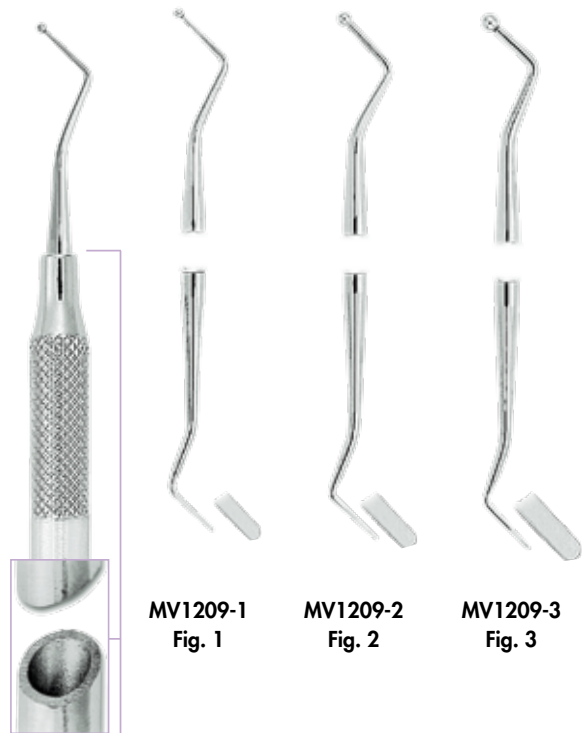

MV1209-1
Fig. 1

MV1209-2
Fig. 2

MV1209-3
Fig. 3

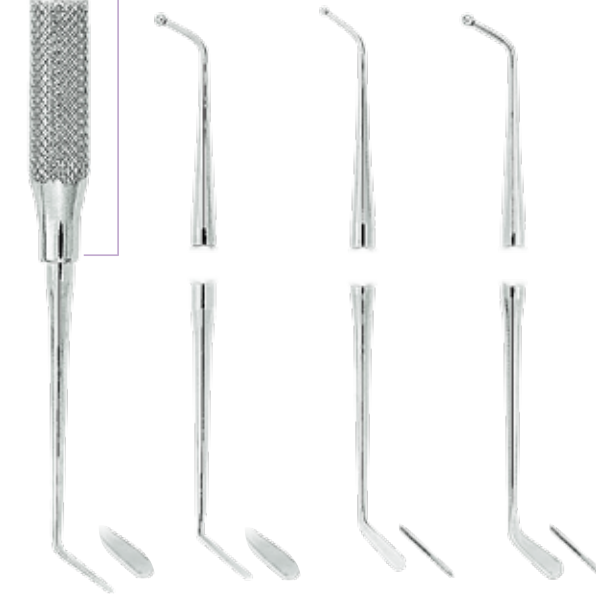

MV1206-1
Fig. 1

MV1206-2
Fig. 2

MV1207-1
Fig. 1

MV1207-2
Fig. 2

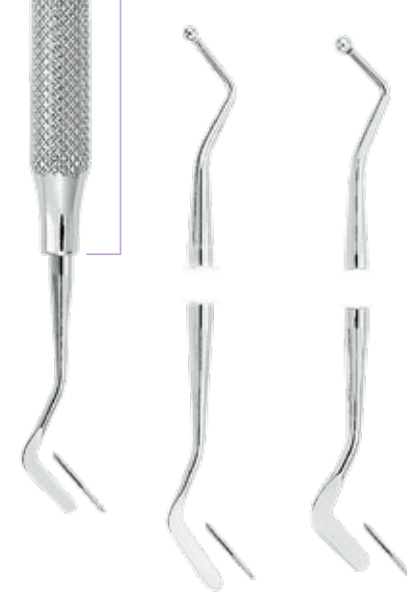

MV1208-1
Fig. 1

MV1208-2
Fig. 2

MV1208-3
Fig. 3

Dove nasce un sorriso...
Where smile rises...



Strumenti per Otturazioni Plastiche

Plastic Filling Instruments



Conservativa - Restorative



1216-1
Fig. 1
Woodson



1217-11
Fig. 11



1216-2
Fig. 2
Woodson



1218-6
Fig. 6



1216-3
Fig. 3
Woodson



1219-179
Fig. 179



MV1216-1
Fig. 1
Woodson



MV1217-11
Fig. 11



MV1216-2
Fig. 2
Woodson



MV1218-6
Fig. 6



MV1216-3
Fig. 3
Woodson



MV1219-179
Fig. 179

Dove nasce un sorriso...
Where smile rises...



Strumenti per Modellare e Rfinire Otturazioni

Amalgam Carvers



1500-02 Modellatore fine per otturazioni Hollenback fig. 1/2
Hollenback small amalgam carver fig.1/2

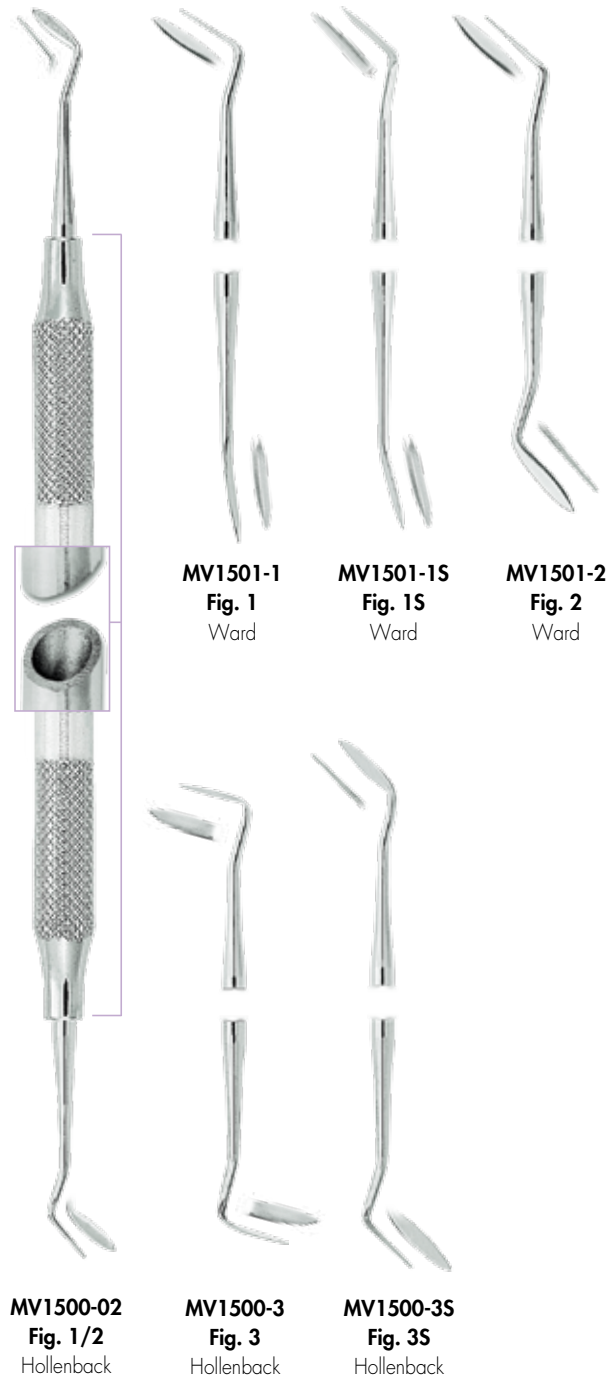

Dove nasce un sorriso...
Where smile rises...



Strumenti per Modellare e Rifinire Otturazioni

Amalgam Carvers

Conservativa - Restorative



1502-1
Fig. 1
Frahm

1503-2
Fig. 2
USC

1504-1
Fig. 1
Interproximal

1504-2
Fig. 2
Interproximal
Off-Angle

1505-A
Fig. SHO-A

1505-3
Fig. 3-SHO

1506-104
Fig. 104

1507-8
Fig. 8
Wiland

Dove nasce un sorriso...
Where smile rises...



Strumenti per Modellare e Rfinire Otturazioni

Amalgam Carvers

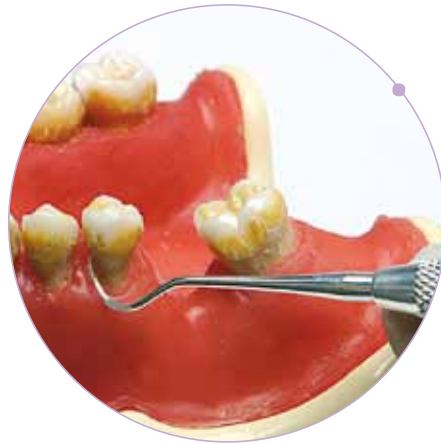

MV1507-8

Modellatore per otturazioni interprossimali Wiland
Wiland amalgam carver for interproximal fillings

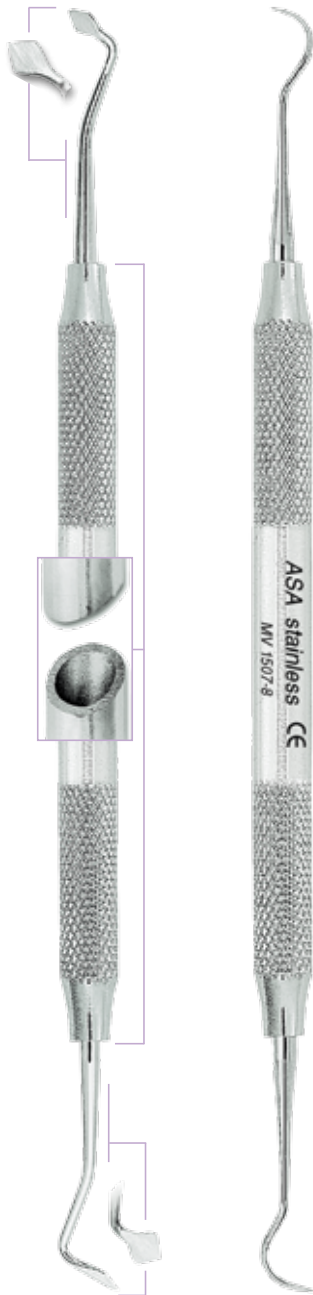

MV1502-1
Fig. 1
Frahm

MV1507-8
Fig. 8
Wiland



1310-1 Strumento per inserimento filo retrattore
Instrument for retractor wire

Strumenti per filo retrattore
Instruments for retractor wire



1310-1

1310-2

Dove nasce un sorriso...
Where smile rises...



Strumenti per Trattamento Conservativo

Operative Instruments

1355-1

mm. 2
Luniatschek



Porta-tamponi
Gauze packers



1355-2

mm. 3
Luniatschek

Strumento per l'applicazione
di tinture e medicamenti
*Instrument for subgingival
application of tinctures and medicaments*



1303
Orban Loop



1300

Applicatori per sottofondo
Placement instruments



1301

1302

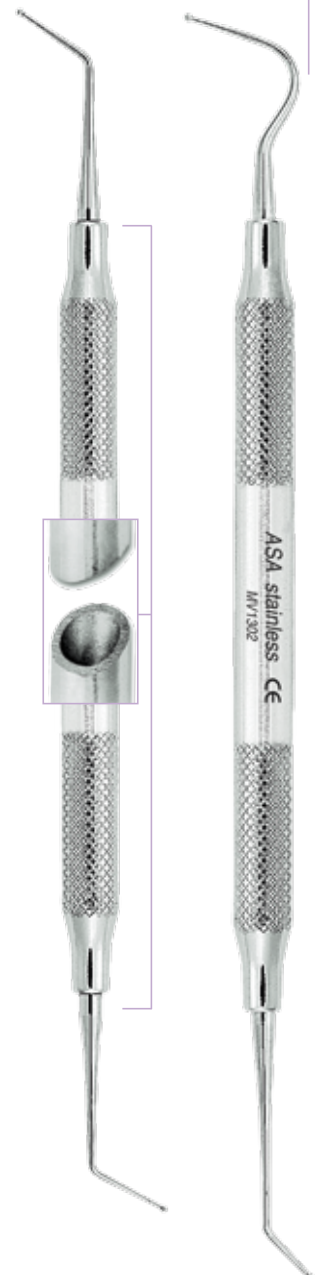

MV1301

MV1302

Dove nasce un sorriso...
Where smile rises...

ASA DENTAL®

Strumenti per Modellare e Rfinire Otturazioni

Amalgam Carvers



1600-3

Modellatore cleoide-discoide parte lavorante ovale
Cleoids-discoids amalgam carver, oval working tip



Cleoids-Discoids

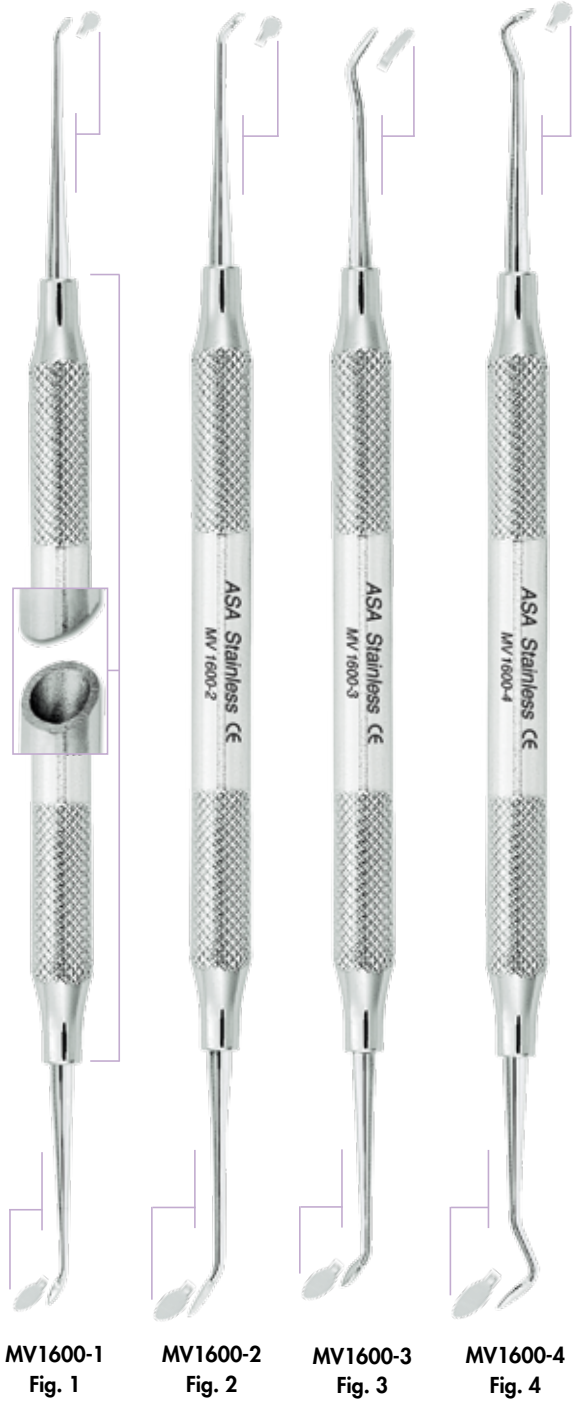

Cleoids-Discoids

Conservativa - Restorative

Dove nasce un sorriso...
Where smile rises...



Strumenti da Smalto

Cavity Preparation Instruments

Conservativa - Restorative



1601-1
Fig. 1
Black/26

Distal



1603-1
Fig. 1
Black/53-54



1603-2
Fig. 2
Black/51-52



1604-02
Fig. 1/2
Wedelstaet



1604-04
Fig. 3/4
Wedelstaet



1604-06
Fig. 5/6
Wedelstaet

Finitori per bordi gengivali
Gingival margin trimmers



1601-2
Fig. 2
Black/27

Mesial



1601-3
Fig. 3
Black/28

Distal



1601-4
Fig. 4
Black/29

Mesial



1602-1
Fig. 1
Black/77-78

Distal



1602-2
Fig. 2
Black/79-80

Mesial

Dove nasce un sorriso...
Where smile rises...



Strumenti da Smalto

Cavity Preparation Instruments



MV1601-1
Fig. 1
Black/26

Distal



MV1603-1
Fig. 1
Black/53-54



MV1603-2
Fig. 2
Black/51-52



MV1604-02
Fig. 1/2
Wedelstaet



MV1604-04
Fig. 3/4
Wedelstaet



MV1604-06
Fig. 5/6
Wedelstaet

Finitori per bordi gengivali
Gingival margin trimmers



MV1601-2
Fig. 2
Black/27

Mesial



MV1601-3
Fig. 3
Black/28

Distal



MV1601-4
Fig. 4
Black/29

Mesial



MV1602-1
Fig. 1
Black/77-78

Distal



MV1602-2
Fig. 2
Black/79-80

Mesial

Dove nasce un sorriso...
Where smile rises...

ASA DENTAL®

Escavatori

Excavators

S1700-0

Serie da 5 pezzi Fig. 0
Set of 5 Fig. 0

S1700-1

Serie da 5 pezzi Fig. 1
Set of 5 Fig. 1

S1700-2

Serie da 5 pezzi Fig. 2
Set of 5 Fig. 2

S1700-3

Serie da 5 pezzi Fig. 3
Set of 5 Fig. 3

S1700-4

Serie da 5 pezzi Fig. 4
Set of 5 Fig. 4

S1700

Serie da 5 pezzi
Set of 5



1700-0
Fig. 0



1700-1
Fig. 1



1700-2
Fig. 2



1700-3
Fig. 3



1700-4
Fig. 4



1701-1
Fig. 1



1701-2
Fig. 2

Dove nasce un sorriso...
Where smile rises...

ASA DENTAL®

Escavatori

Excavators

ASA
LIGHT



SMV1700
Serie da 5 pezzi
Set of 5



MV1700-1 Escavatore per rimozione manuale di tessuto carioso
Excavator for manual removal of decay tissue



MV1700-0
Fig. 0



MV1700-1
Fig. 1



MV1700-2
Fig. 2



MV1700-3
Fig. 3



MV1700-4
Fig. 4



MV1701-1
Fig. 1



MV1701-2
Fig. 2

Dove nasce un sorriso...
Where smile rises...



Escavatori

Excavators

Conservativa - Restorative



1702-6
Fig. 6



1707-39
Fig. 38/39



1703-14
Fig. 14



1704-17
Fig. 17



1704-17W
Fig. 17W
Oval spoon



1705-18
Fig. 18



1705-18W
Fig. 18W
Oval spoon



1706-19
Fig. 19



1706-19W
Fig. 19W
Oval spoon



1703-14 Escavatore a forma angolare con punta arrotondata
Angular shaped excavator with rounded tip



1709-31L
Fig. 31L



1709-32L
Fig. 32L



1709-33L
Fig. 33L

Dove nasce un sorriso...
Where smile rises...



Escavatori

Excavators

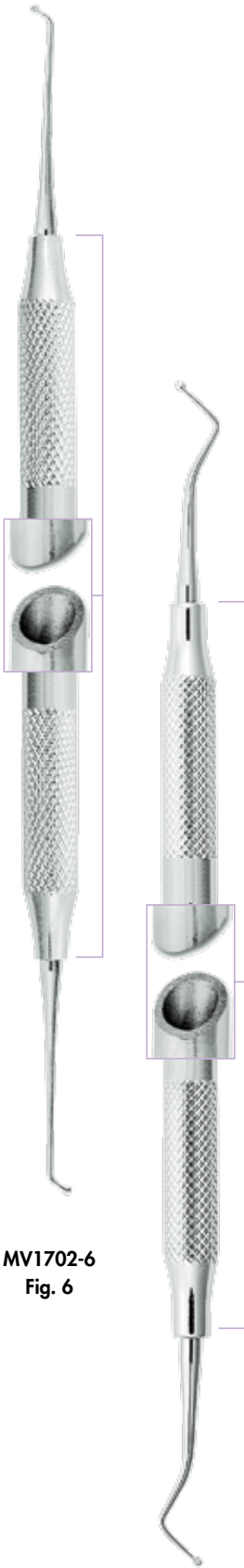

MV1702-6
Fig. 6

MV1707-39
Fig. 38/39

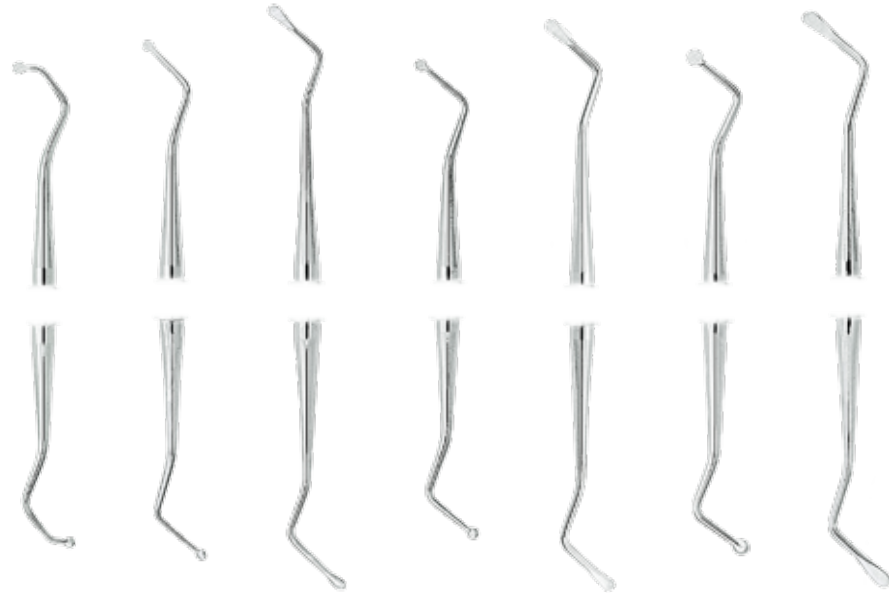

MV1703-14 Fig. 14 MV1704-17 Fig. 17 MV1704-17W Fig. 17W
Oval spoon MV1705-18 Fig. 18 MV1705-18W Fig. 18W
Oval spoon MV1706-19 Fig. 19 MV1706-19W Fig. 19W
Oval spoon

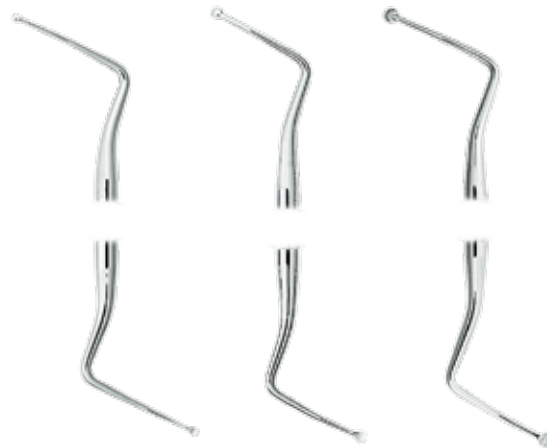

MV1709-31L
Fig. 31L

MV1709-32L
Fig. 32L

MV1709-33L
Fig. 33L

Dove nasce un sorriso...
Where smile rises...



Escavatori

Excavators

■ **Mod. SS. White**
SS. White type

S1710-6
Serie da 6 pezzi
Set of 6



1 mm

1,2 mm

1 mm

1,2 mm

1,6 mm

2 mm



1710-17 Escavatore per rimozione manuale di tessuto carioso

Excavator for manual removal of decay tissue



1710-5
Fig. 5



1710-14
Fig. 14



1710-17
Fig. 17



1710-18
Fig. 18



1710-19
Fig. 19



1710-20
Fig. 20

Dove nasce un sorriso...
Where smile rises...



Escavatori

Excavators

1 mm



1711-243
Fig. 243
ASH

1,4 mm



1711-G2
Fig. G2
ASH

0,8 mm



1711-1
Fig. 1
Darby-Perry

0,8 mm



1711-2
Fig. 2
Darby-Perry

1 mm



1711-11
Fig. 11
Darby-Perry

1 mm



1711-12
Fig. 12
Darby-Perry

1,2 mm



1711-21
Fig. 21
Darby-Perry

1,2 mm



1711-22
Fig. 22
Darby-Perry

1,6 mm



1711-31
Fig. 31
Darby-Perry

1,6 mm



1711-32
Fig. 32
Darby-Perry

2 mm



1711-41
Fig. 41
Darby-Perry

2 mm



1711-42
Fig. 42
Darby-Perry

Dove nasce un sorriso...
Where smile rises...

ASA DENTAL®

Escavatori

Excavators

■ Mod. SS. White
SS. White type

SML1710-6

Serie da 6 pezzi
Set of 6

Contenuto/Contents:

ML1710-5, ML1710-14, ML1710-17,
ML1710-18, ML1710-19, ML1710-20



1 mm



ML1710-5
Fig. 5

1,2 mm



ML1710-14
Fig. 14

1 mm



ML1710-17
Fig. 17

1,2 mm



ML1710-18
Fig. 18

1,6 mm



ML1710-19
Fig. 19

2 mm



ML1710-20
Fig. 20

Dove nasce un sorriso...
Where smile rises...



Escavatori

Excavators



ML1711-11

Escavatore per rimozione manuale di tessuto carioso
Excavator for manual removal of decay tissue

1 mm

1,4 mm

0,8 mm

0,8 mm

1 mm

1 mm

1,2 mm



ML1711-1
Fig. 1
Darby-Perry

ML1711-2
Fig. 2
Darby-Perry

ML1711-11
Fig. 11
Darby-Perry

ML1711-12
Fig. 12
Darby-Perry

ML1711-21
Fig. 21
Darby-Perry

1,2 mm

1,6 mm

1,6 mm

2 mm

2 mm



ML1711-243
Fig. 243
ASH

ML1711-G2
Fig. G2
ASH

ML1711-22
Fig. 22
Darby-Perry

ML1711-31
Fig. 31
Darby-Perry

ML1711-32
Fig. 32
Darby-Perry

ML1711-41
Fig. 41
Darby-Perry

ML1711-42
Fig. 42
Darby-Perry

Dove nasce un sorriso...
Where smile rises...



Strumenti per Corone

Crown Instruments



2305-D Estrattore per ponti e corone
Crowns and bridges remover

Martelletti levacorone
Crown removers

Completo con 3 punte
Complete with 3 attachments



2306 **2307** **2308**

Punte
Attachments



2305-D



2320

Strumento levacorone e apicorone.
Strumento speciale per aprire le corone dopo
la separazione; funzionamento facile e sicuro.

Crown Spreader, Crown Remover.
Special instrument for crown spreading after
separating, simple and safe operation.

Completi con 2 punte
Complete with 2 attachments

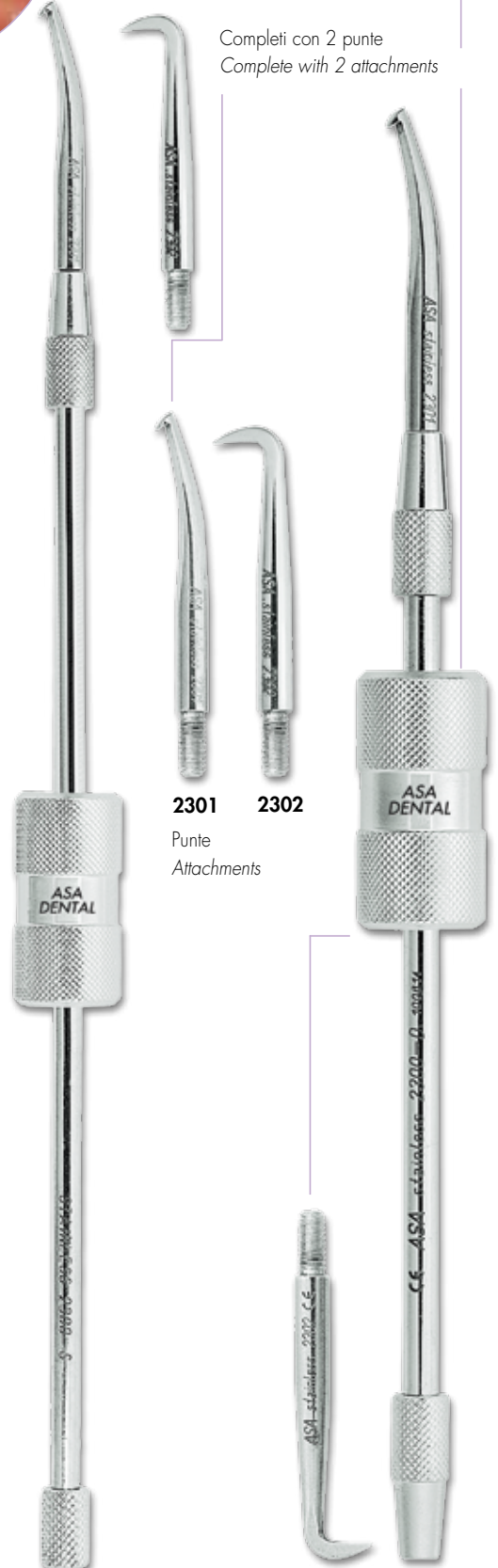

2301 **2302**

Punte
Attachments

2300-S

2300-D

Dove nasce un sorriso...
Where smile rises...



Strumenti per Corone

Crown Instruments



2555
Boley
cm. 14

Misurazione }
Measuring range } 0-100 mm.

Calibro decimale
Decimal caliper

2550-1
Per cera
For wax



2550-2
Per metallo
For metal



Misurazione:
Measuring range:

0-10 mm.

Iwanson

Pinze per togliere anelli di rame
Copper rings removing pliers



Retta
Straight

2331-1
Furrer
cm. 16



Curva
Curved

2331-2
Furrer
cm. 16

Dove nasce un sorriso...
Where smile rises...



Strumenti per Corone

Crown Instruments

Conservativa - Restorative

Apricorone
Crown spreaders



2340-0
Fig. 0



2340-1
Fig. 1



2340-2
Fig. 2



2340-3
Fig. 3
Universal



Pinzette per carta da articolazione
Articulating paper forceps



0670
Miller
cm.15



0671
cm.15

Strumenti per Corone

Crown Instruments

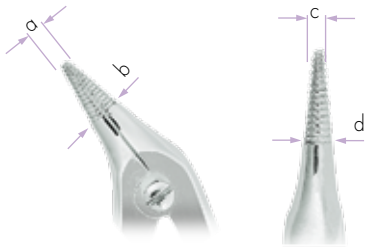

a	3,3 mm	c	2,3 mm
b	4 mm	d	3 mm



a	4,4 mm	c	3,4 mm
b	5 mm	d	3,8 mm

Pinze telescopiche per corone
Telescope crown pliers

2500-1
Bohm
cm. 11,5

2500-2
Bohm
cm. 14,5



Rette
Straight

0510-1
Fig. 1
Kelly
cm. 14



Rette
Straight

0500-1
Fig. 1
Halstead-Mosquito
cm. 12



Rette
Straight

0501-1
Fig. 1
Micro-Mosquito
cm. 10

Dove nasce un sorriso...
Where smile rises...



Forbici Universali - Forbici per Corone

Foil, Wire and Plate Scissors - Crown Scissors

■ Forbici per foglio d'oro
Scissors for gold foils



0300-1
Fig. 1
cm. 12

Rette
Straight

Con lame al carburo
di tungsteno
With tungsten
carbide blades



5700TC
cm. 12
Universal



5700
cm. 12
Universal



5600-1
Fig. 1
cm. 10,5

Rette, una lama
dentellata
Straight, one
blade serrated



5600-2
Fig. 2
cm. 10,5

Curve, una lama
dentellata
Curved, one
blade serrated



5601-1
Fig. 1
cm. 10,5

Rette
Straight



5601-2
Fig. 2
cm. 10,5

Curve
Curved

Porta Matrici

Matrix Retainers

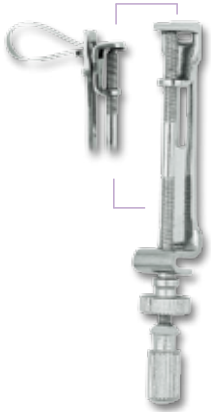

3070-5
Fig. 5
Ivory 8
mm 5



Inserimento corretto del portamatrice sul molare
Correct placement of matrix retainer on molar



3070-6
Fig. 6
Ivory 8
mm 6



3070-7
Fig. 7
Ivory 8
mm 7



3073-1
Fig. 1
Tofflemire-Universal

3071
Ivory 8 N



3072
Didner 8 P



3073-2
Fig. 2
Tofflemire-Junior



3073-1
Portamatrice universale Tofflemire
Tofflemire universal matrix retainer

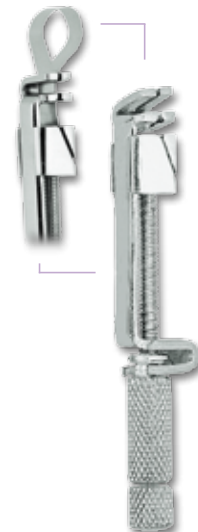

3073-3
Fig. 3
Tofflemire-Senior

Dove nasce un sorriso...
Where smile rises...



Matrici

Matrix Bands

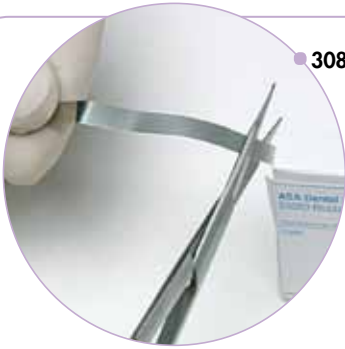

● **3082-6** Matrice a nastro
Matrix band



3082-5
mm. 5 x cm. 100



3082-6
mm. 6 x cm. 100



3082-7
mm. 7 x cm. 100

- 3070-5
- 3071
- 3072
- 3073-1
- 3073-2
- 3073-3

Per porta matrici:
For matrix retainers:

- 3070-6
- 3070-7
- 3071
- 3072
- 3073-1
- 3073-2
- 3073-3

- 3070-7
- 3071
- 3072
- 3073-1
- 3073-2
- 3073-3

Assortiti in confezione da 12 pz
Assorted in package of 12



3081
Tofflemire

Contenuto/Contents: 3081-1, 3081-2, 3081-3.

Confezione da 12 pz per tipo
12 each per package

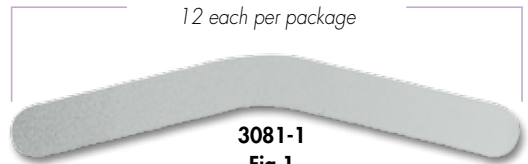

3081-1
Fig.1
Tofflemire



3081-2
Fig.2
Tofflemire



3081-3
Fig.3
Tofflemire